

# KW DPLS32.EC

## SYNIOS® E4014

This compact LED offers an extremely low-profile and compact design of 4.0 x 1.4 x 0.65 mm, uniform distribution of light and rugged plastic housing.

The warm white KW DPLS32.EC is targeted at applications for indoor lighting in automobiles (ceiling, navigation, lighting) and aircraft.



## Applications

- Electronic Equipment
- Interior Illumination (e.g. Ambient Map)
- Transportation, Plane, Ship
- White Goods

## Features:

- Package: SMD epoxy package, colored silicone resin
- Chip technology: InGaN on Sapphire
- Typ. Radiation: 120° (Lambertian emitter)
- Color: Cx = , Cy = acc. to CIE 1931 (● white)
- Optical efficacy: 110 lm/W
- Corrosion Robustness Class: 1B
- Color temperature: 2700K - 6500K
- CRI: 80 (min.)
- ESD: 8 kV acc. to ANSI/ESDA/JEDEC JS-001 (HBM, Class 3B)

## Ordering Information

Type	Color temperature	Luminous Flux <sup>1)</sup> $I_F = 120 \text{ mA}$ $\Phi_V$	Ordering Code
KW DPLS32.EC-6H6J-4U8X-1	2700 K	31.5 ... 56.0 lm	Q65111A7739
KW DPLS32.EC-6H6J-4R8T-1	3000 K	31.5 ... 56.0 lm	Q65111A5893
KW DPLS32.EC-6H6J-4O8Q	3500 K	31.5 ... 56.0 lm	Q65111A6346
KW DPLS32.EC-6H6J-4L8N-1	4000 K	31.5 ... 56.0 lm	Q65111A5889
KW DPLS32.EC-6H6J-4J8K-1	4500 K	31.5 ... 56.0 lm	Q65111A5890
KW DPLS32.EC-6H6J-4H8I-1	5000 K	31.5 ... 56.0 lm	Q65111A8478
KW DPLS32.EC-6H6J-4F8G-1	5700 K	31.5 ... 56.0 lm	Q65111A5891
KW DPLS32.EC-6H6J-4C8E-1	6500 K	31.5 ... 56.0 lm	Q65111A5892

## Maximum Ratings

Parameter	Symbol		Values
Operating Temperature	$T_{op}$	min.	-40 °C
		max.	100 °C
Storage Temperature	$T_{stg}$	min.	-40 °C
		max.	100 °C
Junction Temperature	$T_j$	max.	125 °C
Forward Current $T_s = 25\text{ °C}$	$I_F$	min.	5 mA
		max.	180 mA
ESD withstand voltage acc. to ANSI/ESDA/JEDEC JS-001 (HBM, Class 3B)	$V_{ESD}$		8 kV
Reverse voltage <sup>2)</sup>	$V_R$		Not designed for reverse operation

## Characteristics

$I_F = 120 \text{ mA}$ ;  $T_s = 25 \text{ °C}$

Parameter	Symbol		Values
Viewing angle at 50 % $I_v$	$2\phi$	typ.	120 °
Forward Voltage <sup>3)</sup> $I_F = 120 \text{ mA}$	$V_F$	min. typ. max.	2.80 V 3.15 V 3.40 V
Reverse current <sup>2)</sup>	$I_R$		Not designed for reverse operation
Color Rendering Index	CRI	min.	80
Real thermal resistance junction/solderpoint <sup>4)</sup>	$R_{thJS \text{ real}}$	typ. max.	36 K / W 50 K / W
Electrical thermal resistance junction/solderpoint <sup>4)</sup> with efficiency $\eta_e = 35 \%$	$R_{thJS \text{ elec.}}$	typ. max.	23 K / W 33 K / W

## Brightness Groups

Group	Luminous Flux <sup>1)</sup> $I_F = 120 \text{ mA}$ min. $\Phi_V$	Luminous Flux <sup>1)</sup> $I_F = 120 \text{ mA}$ max. $\Phi_V$	Luminous Intensity <sup>5)</sup> $I_F = 120 \text{ mA}$ typ. $I_v$
6H	31.5 lm	35.5 lm	11.1 cd
7H	35.5 lm	40.0 lm	12.5 cd
8H	40.0 lm	45.0 lm	14.0 cd
5J	45.0 lm	50.0 lm	15.7 cd
6J	50.0 lm	56.0 lm	17.5 cd

## Forward Voltage Groups

Group	Forward Voltage <sup>3)</sup> $I_F = 120 \text{ mA}$ min. $V_F$	Forward Voltage <sup>3)</sup> $I_F = 120 \text{ mA}$ max. $V_F$
24	2.80 V	3.00 V
64	3.00 V	3.20 V
A4	3.20 V	3.40 V

## Chromaticity Coordinate Groups <sup>6)</sup>

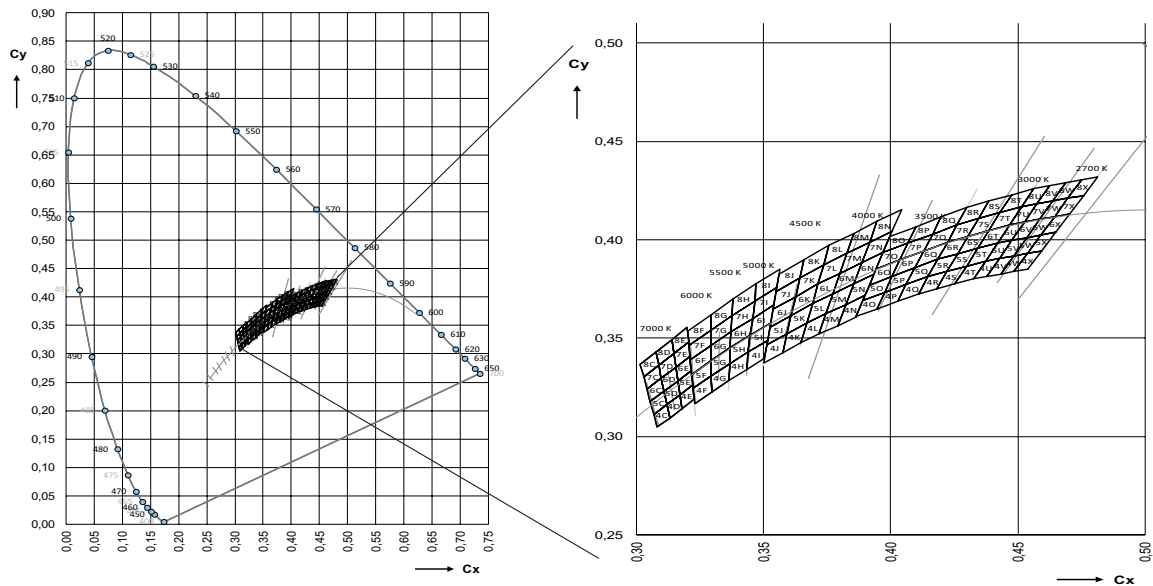

## Color Chromaticity Groups <sup>6)</sup>

Group	Cx	Cy	CCT	Group	Cx	Cy	CCT	Group	Cx	Cy	CCT
4U	0.4326	0.3801	2700	5U	0.4373	0.3893	2700	6U	0.4420	0.3985	2700
	0.4373	0.3893	2700		0.4420	0.3985	2700		0.4468	0.4077	2700
	0.4428	0.3906	2700		0.4477	0.3998	2700		0.4526	0.4090	2700
	0.4379	0.3814	2700		0.4428	0.3906	2700		0.4477	0.3998	2700
4V	0.4379	0.3814	2700	5V	0.4428	0.3906	2700	6V	0.4477	0.3998	2700
	0.4428	0.3906	2700		0.4477	0.3998	2700		0.4526	0.4090	2700
	0.4483	0.3919	2700		0.4534	0.4011	2700		0.4585	0.4104	2700
	0.4432	0.3826	2700		0.4483	0.3919	2700		0.4534	0.4011	2700
4W	0.4432	0.3826	2700	5W	0.4483	0.3919	2700	6W	0.4534	0.4011	2700
	0.4483	0.3919	2700		0.4534	0.4011	2700		0.4585	0.4104	2700
	0.4538	0.3931	2700		0.4591	0.4025	2700		0.4644	0.4118	2700
	0.4485	0.3838	2700		0.4538	0.3931	2700		0.4591	0.4025	2700
4X	0.4485	0.3838	2700	5X	0.4538	0.3931	2700	6X	0.4591	0.4025	2700
	0.4538	0.3931	2700		0.4591	0.4025	2700		0.4644	0.4118	2700
	0.4593	0.3944	2700		0.4648	0.4038	2700		0.4703	0.4132	2700
	0.4538	0.3850	2700		0.4593	0.3944	2700		0.4648	0.4038	2700

Group	Cx	Cy	CCT	Group	Cx	Cy	CCT	Group	Cx	Cy	CCT
7U	0.4468	0.4077	2700	4R	0.4109	0.3726	3000	6T	0.4342	0.3957	3000
	0.4515	0.4168	2700		0.4147	0.3814	3000		0.4386	0.4048	3000
	0.4576	0.4183	2700		0.4222	0.3840	3000		0.4468	0.4077	3000
	0.4526	0.4090	2700		0.4181	0.3751	3000		0.4420	0.3985	3000
7V	0.4526	0.4090	2700	4S	0.4181	0.3751	3000	7R	0.4223	0.3990	3000
	0.4576	0.4183	2700		0.4222	0.3840	3000		0.4261	0.4077	3000
	0.4636	0.4197	2700		0.4298	0.3867	3000		0.4346	0.4108	3000
	0.4585	0.4104	2700		0.4254	0.3776	3000		0.4305	0.4019	3000
7W	0.4585	0.4104	2700	4T	0.4254	0.3776	3000	7S	0.4305	0.4019	3000
	0.4636	0.4197	2700		0.4298	0.3867	3000		0.4346	0.4108	3000
	0.4697	0.4211	2700		0.4373	0.3893	3000		0.4430	0.4138	3000
	0.4644	0.4118	2700		0.4326	0.3801	3000		0.4386	0.4048	3000
7X	0.4644	0.4118	2700	5R	0.4147	0.3814	3000	7T	0.4386	0.4048	3000
	0.4697	0.4211	2700		0.4185	0.3902	3000		0.4430	0.4138	3000
	0.4758	0.4225	2700		0.4263	0.3929	3000		0.4515	0.4168	3000
	0.4703	0.4132	2700		0.4222	0.3840	3000		0.4468	0.4077	3000
8U	0.4515	0.4168	2700	5S	0.4222	0.3840	3000	8R	0.4261	0.4077	3000
	0.4562	0.4260	2700		0.4263	0.3929	3000		0.4299	0.4165	3000
	0.4625	0.4275	2700		0.4342	0.3957	3000		0.4387	0.4197	3000
	0.4576	0.4183	2700		0.4298	0.3867	3000		0.4346	0.4108	3000
8V	0.4576	0.4183	2700	5T	0.4298	0.3867	3000	8S	0.4346	0.4108	3000
	0.4625	0.4275	2700		0.4342	0.3957	3000		0.4387	0.4197	3000
	0.4688	0.4290	2700		0.4420	0.3985	3000		0.4474	0.4228	3000
	0.4636	0.4197	2700		0.4373	0.3893	3000		0.4430	0.4138	3000
8W	0.4636	0.4197	2700	6R	0.4185	0.3902	3000	8T	0.4430	0.4138	3000
	0.4688	0.4290	2700		0.4223	0.3990	3000		0.4474	0.4228	3000
	0.4750	0.4304	2700		0.4305	0.4019	3000		0.4562	0.4260	3000
	0.4697	0.4211	2700		0.4263	0.3929	3000		0.4515	0.4168	3000
8X	0.4697	0.4211	2700	6S	0.4263	0.3929	3000	4O	0.3863	0.3609	3500
	0.4750	0.4304	2700		0.4305	0.4019	3000		0.3890	0.3690	3500
	0.4813	0.4319	2700		0.4386	0.4048	3000		0.3975	0.3731	3500
	0.4758	0.4225	2700		0.4342	0.3957	3000		0.3945	0.3648	3500

Group	Cx	Cy	CCT	Group	Cx	Cy	CCT	Group	Cx	Cy	CCT
4P	0.3945	0.3648	3500	7O	0.3943	0.3853	3500	4N	0.3791	0.3564	4000
	0.3975	0.3731	3500		0.3970	0.3934	3500		0.3822	0.3670	4000
	0.4061	0.3773	3500		0.4067	0.3982	3500		0.3898	0.3716	4000
	0.4027	0.3687	3500		0.4036	0.3898	3500		0.3862	0.3607	4000
4Q	0.4027	0.3687	3500	7P	0.4036	0.3898	3500	5L	0.3670	0.3578	4000
	0.4061	0.3773	3500		0.4067	0.3982	3500		0.3692	0.3677	4000
	0.4147	0.3814	3500		0.4164	0.4029	3500		0.3773	0.3726	4000
	0.4109	0.3726	3500		0.4130	0.3944	3500		0.3746	0.3624	4000
5O	0.3890	0.3690	3500	7Q	0.4130	0.3944	3500	5M	0.3746	0.3624	4000
	0.3916	0.3772	3500		0.4164	0.4029	3500		0.3773	0.3726	4000
	0.4006	0.3815	3500		0.4261	0.4077	3500		0.3853	0.3776	4000
	0.3975	0.3731	3500		0.4223	0.3990	3500		0.3822	0.3670	4000
5P	0.3975	0.3731	3500	8O	0.3970	0.3934	3500	5N	0.3822	0.3670	4000
	0.4006	0.3815	3500		0.3997	0.4015	3500		0.3853	0.3776	4000
	0.4095	0.3858	3500		0.4097	0.4065	3500		0.3934	0.3825	4000
	0.4061	0.3773	3500		0.4067	0.3982	3500		0.3898	0.3716	4000
5Q	0.4061	0.3773	3500	8P	0.4067	0.3982	3500	6L	0.3692	0.3677	4000
	0.4095	0.3858	3500		0.4097	0.4065	3500		0.3714	0.3775	4000
	0.4185	0.3902	3500		0.4198	0.4115	3500		0.3799	0.3828	4000
	0.4147	0.3814	3500		0.4164	0.4029	3500		0.3773	0.3726	4000
6O	0.3916	0.3772	3500	8Q	0.4164	0.4029	3500	6M	0.3773	0.3726	4000
	0.3943	0.3853	3500		0.4198	0.4115	3500		0.3799	0.3828	4000
	0.4036	0.3898	3500		0.4299	0.4165	3500		0.3885	0.3882	4000
	0.4006	0.3815	3500		0.4261	0.4077	3500		0.3853	0.3776	4000
6P	0.4006	0.3815	3500	4L	0.3648	0.3479	4000	6N	0.3853	0.3776	4000
	0.4036	0.3898	3500		0.3670	0.3578	4000		0.3885	0.3882	4000
	0.4130	0.3944	3500		0.3746	0.3624	4000		0.3970	0.3935	4000
	0.4095	0.3858	3500		0.3719	0.3522	4000		0.3934	0.3825	4000
6Q	0.4095	0.3858	3500	4M	0.3719	0.3522	4000	7L	0.3714	0.3775	4000
	0.4130	0.3944	3500		0.3746	0.3624	4000		0.3736	0.3874	4000
	0.4223	0.3990	3500		0.3822	0.3670	4000		0.3826	0.3931	4000
	0.4185	0.3902	3500		0.3791	0.3564	4000		0.3799	0.3828	4000



Group	Cx	Cy	CCT	Group	Cx	Cy	CCT	Group	Cx	Cy	CCT
7M	0.3799	0.3828	4000	5K	0.3591	0.3522	4500	4I	0.3433	0.3341	5000
	0.3826	0.3931	4000		0.3608	0.3616	4500		0.3441	0.3428	5000
	0.3916	0.3987	4000		0.3692	0.3677	4500		0.3515	0.3487	5000
	0.3885	0.3882	4000		0.3670	0.3578	4500		0.3503	0.3396	5000
7N	0.3885	0.3882	4000	6J	0.3524	0.3555	4500	5H	0.3366	0.3369	5000
	0.3916	0.3987	4000		0.3536	0.3646	4500		0.3369	0.3451	5000
	0.4006	0.4044	4000		0.3625	0.3711	4500		0.3448	0.3515	5000
	0.3970	0.3935	4000		0.3608	0.3616	4500		0.3441	0.3428	5000
8L	0.3736	0.3874	4000	6K	0.3608	0.3616	4500	5I	0.3441	0.3428	5000
	0.3758	0.3973	4000		0.3625	0.3711	4500		0.3448	0.3515	5000
	0.3853	0.4033	4000		0.3714	0.3775	4500		0.3527	0.3578	5000
	0.3826	0.3931	4000		0.3692	0.3677	4500		0.3515	0.3487	5000
8M	0.3826	0.3931	4000	7J	0.3536	0.3646	4500	6H	0.3369	0.3451	5000
	0.3853	0.4033	4000		0.3548	0.3736	4500		0.3373	0.3534	5000
	0.3947	0.4093	4000		0.3642	0.3805	4500		0.3456	0.3601	5000
	0.3916	0.3987	4000		0.3625	0.3711	4500		0.3448	0.3515	5000
8N	0.3916	0.3987	4000	7K	0.3625	0.3711	4500	6I	0.3448	0.3515	5000
	0.3947	0.4093	4000		0.3642	0.3805	4500		0.3456	0.3601	5000
	0.4042	0.4153	4000		0.3736	0.3874	4500		0.3539	0.3669	5000
	0.4006	0.4044	4000		0.3714	0.3775	4500		0.3527	0.3578	5000
4J	0.3500	0.3375	4500	8J	0.3548	0.3736	4500	7H	0.3373	0.3534	5000
	0.3512	0.3465	4500		0.3560	0.3826	4500		0.3376	0.3616	5000
	0.3591	0.3522	4500		0.3659	0.3900	4500		0.3464	0.3688	5000
	0.3574	0.3427	4500		0.3642	0.3805	4500		0.3456	0.3601	5000
4K	0.3574	0.3427	4500	8K	0.3642	0.3805	4500	7I	0.3456	0.3601	5000
	0.3591	0.3522	4500		0.3659	0.3900	4500		0.3464	0.3688	5000
	0.3670	0.3578	4500		0.3758	0.3973	4500		0.3551	0.3760	5000
	0.3648	0.3479	4500		0.3736	0.3874	4500		0.3539	0.3669	5000
5J	0.3512	0.3465	4500	4H	0.3363	0.3287	5000	8H	0.3376	0.3616	5000
	0.3524	0.3555	4500		0.3366	0.3369	5000		0.3379	0.3698	5000
	0.3608	0.3616	4500		0.3441	0.3428	5000		0.3471	0.3775	5000
	0.3591	0.3522	4500		0.3433	0.3341	5000		0.3464	0.3688	5000

Group	Cx	Cy	CCT	Group	Cx	Cy	CCT	Group	Cx	Cy	CCT
8I	0.3464	0.3688	5000	7G	0.3292	0.3461	5700	5E	0.3170	0.3212	6500
	0.3471	0.3775	5000		0.3292	0.3539	5700		0.3162	0.3282	6500
	0.3563	0.3851	5000		0.3376	0.3616	5700		0.3216	0.3334	6500
	0.3551	0.3760	5000		0.3373	0.3534	5700		0.3221	0.3262	6500
4F	0.3228	0.3170	5700	8F	0.3206	0.3462	5700	6C	0.3055	0.3177	6500
	0.3222	0.3243	5700		0.3201	0.3534	5700		0.3041	0.3240	6500
	0.3294	0.3306	5700		0.3291	0.3617	5700		0.3098	0.3296	6500
	0.3295	0.3228	5700		0.3292	0.3539	5700		0.3108	0.3229	6500
4G	0.3295	0.3228	5700	8G	0.3292	0.3539	5700	6D	0.3108	0.3229	6500
	0.3294	0.3306	5700		0.3291	0.3617	5700		0.3098	0.3296	6500
	0.3366	0.3369	5700		0.3379	0.3698	5700		0.3154	0.3352	6500
	0.3363	0.3287	5700		0.3376	0.3616	5700		0.3162	0.3282	6500
5F	0.3222	0.3243	5700	4C	0.3081	0.3049	6500	6E	0.3162	0.3282	6500
	0.3217	0.3316	5700		0.3068	0.3113	6500		0.3154	0.3352	6500
	0.3293	0.3384	5700		0.3119	0.3162	6500		0.3210	0.3408	6500
	0.3294	0.3306	5700		0.3130	0.3095	6500		0.3216	0.3334	6500
5G	0.3294	0.3306	5700	4D	0.3130	0.3095	6500	7C	0.3041	0.3240	6500
	0.3293	0.3384	5700		0.3119	0.3162	6500		0.3028	0.3304	6500
	0.3369	0.3451	5700		0.3170	0.3212	6500		0.3087	0.3363	6500
	0.3366	0.3369	5700		0.3178	0.3142	6500		0.3098	0.3296	6500
6F	0.3217	0.3316	5700	4E	0.3178	0.3142	6500	7D	0.3098	0.3296	6500
	0.3212	0.3389	5700		0.3170	0.3212	6500		0.3087	0.3363	6500
	0.3292	0.3461	5700		0.3221	0.3262	6500		0.3146	0.3422	6500
	0.3293	0.3384	5700		0.3226	0.3189	6500		0.3154	0.3352	6500
6G	0.3293	0.3384	5700	5C	0.3068	0.3113	6500	7E	0.3154	0.3352	6500
	0.3292	0.3461	5700		0.3055	0.3177	6500		0.3146	0.3422	6500
	0.3373	0.3534	5700		0.3108	0.3229	6500		0.3205	0.3481	6500
	0.3369	0.3451	5700		0.3119	0.3162	6500		0.3210	0.3408	6500
7F	0.3212	0.3389	5700	5D	0.3119	0.3162	6500	8C	0.3028	0.3304	6500
	0.3206	0.3462	5700		0.3108	0.3229	6500		0.3015	0.3368	6500
	0.3292	0.3539	5700		0.3162	0.3282	6500		0.3076	0.3430	6500
	0.3292	0.3461	5700		0.3170	0.3212	6500		0.3087	0.3363	6500

---

Group	Cx	Cy	CCT	Group	Cx	Cy	CCT
8D	0.3087	0.3363	6500	8E	0.3146	0.3422	6500
	0.3076	0.3430	6500		0.3138	0.3492	6500
	0.3138	0.3492	6500		0.3200	0.3554	6500
	0.3146	0.3422	6500		0.3205	0.3481	6500

---

---

## Group Name on Label

**Example: 5J-4C-24**

Brightness

Color Chromaticity

Forward Voltage

---

5J

4C

24

---

### Relative Spectral Emission <sup>5)</sup>

$\Phi_{rel} = f(\lambda); I_F = 120 \text{ mA}; T_S = 25 \text{ }^\circ\text{C}$

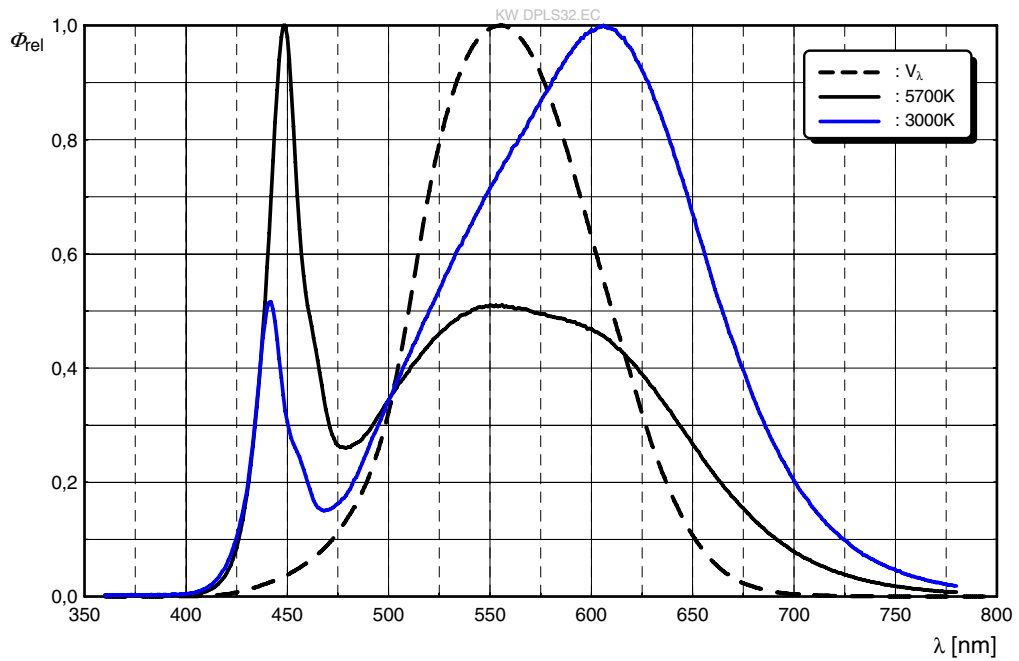

### Radiation Characteristics <sup>5)</sup>

$I_{rel} = f(\phi); T_S = 25 \text{ }^\circ\text{C}$

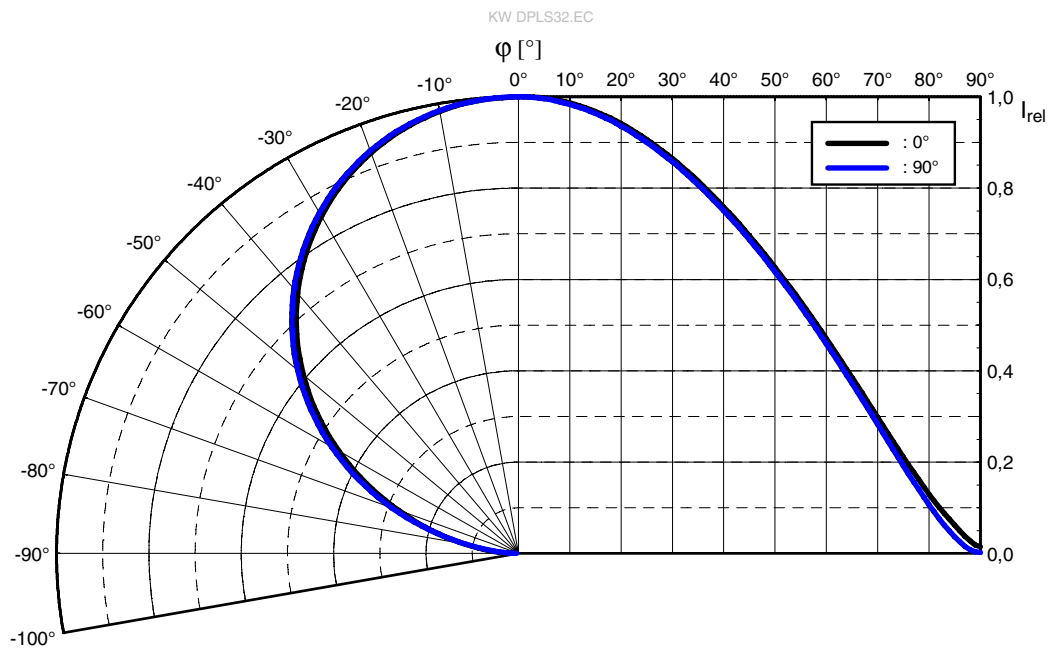

### Forward current <sup>5)</sup>

$$I_F = f(V_F); T_S = 25 \text{ }^\circ\text{C}$$

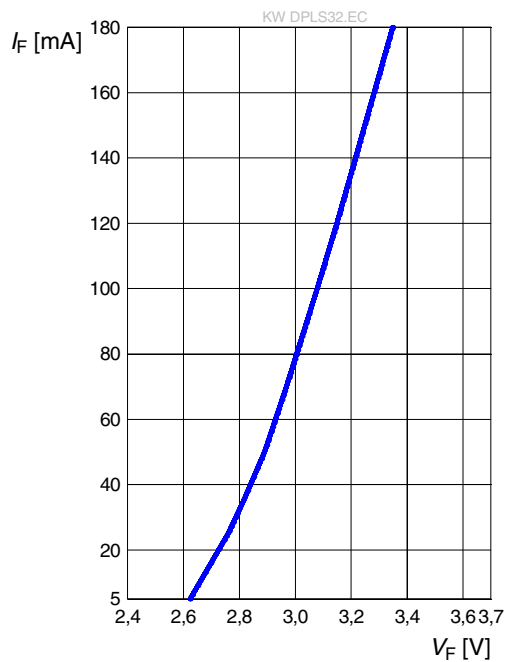

### Relative Luminous Flux <sup>5), 7)</sup>

$$\Phi_V / \Phi_V(120 \text{ mA}) = f(I_F); T_S = 25 \text{ }^\circ\text{C}$$

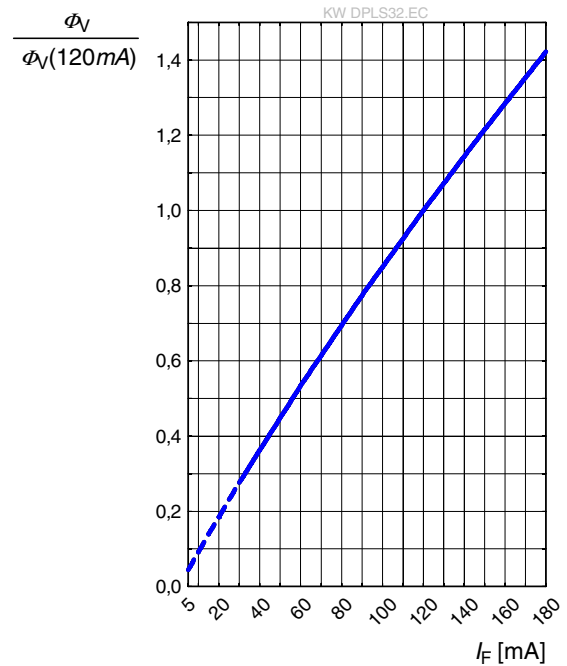

### Chromaticity Coordinate Shift <sup>5)</sup>

$$\Delta C_x, \Delta C_y = f(I_F); T_S = 25 \text{ }^\circ\text{C}$$

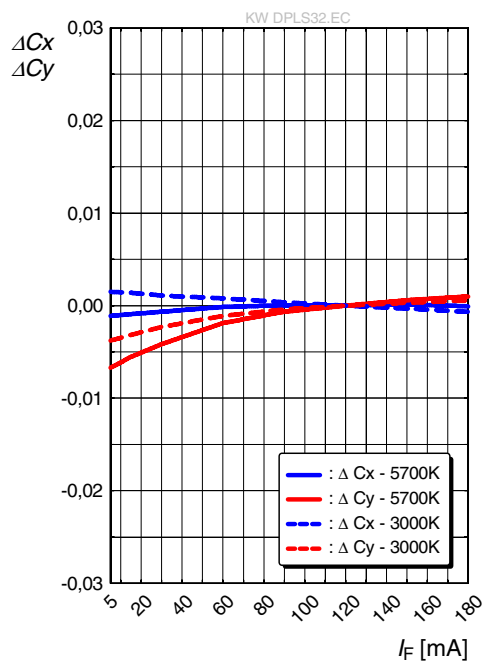

### Forward Voltage <sup>5)</sup>

$$\Delta V_F = V_F - V_F(25\text{ }^\circ\text{C}) = f(T_j); I_F = 120\text{ mA}$$

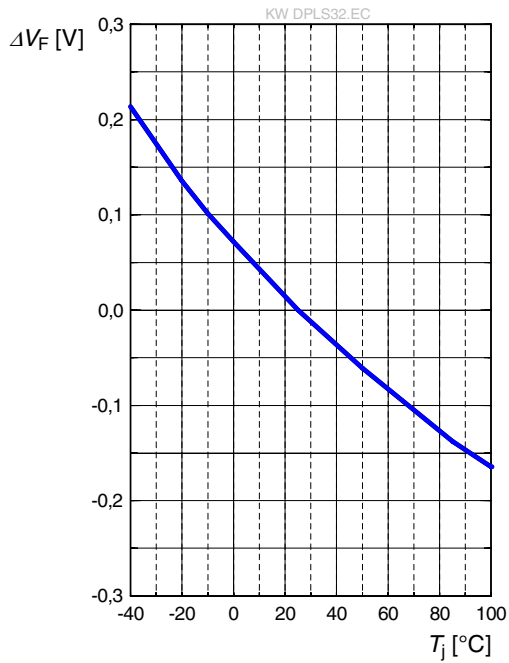

### Relative Luminous Flux <sup>5)</sup>

$$\Phi_V / \Phi_V(25\text{ }^\circ\text{C}) = f(T_j); I_F = 120\text{ mA}$$

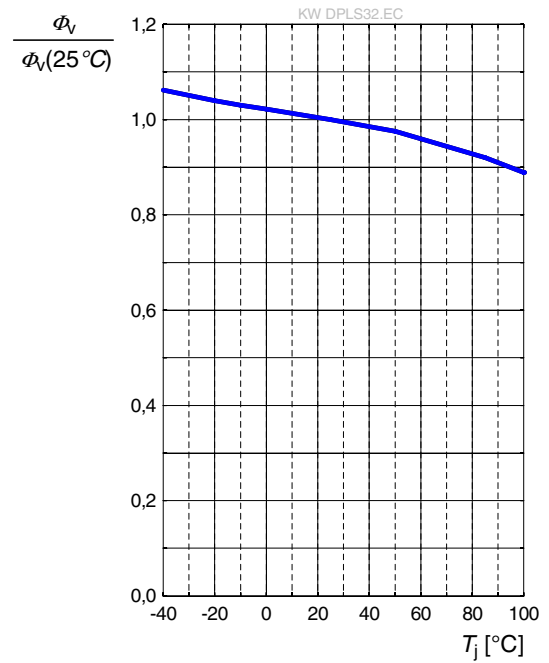

### Chromaticity Coordinate Shift <sup>5)</sup>

$$\Delta C_x, \Delta C_y = f(T_j); I_F = 120\text{ mA}$$

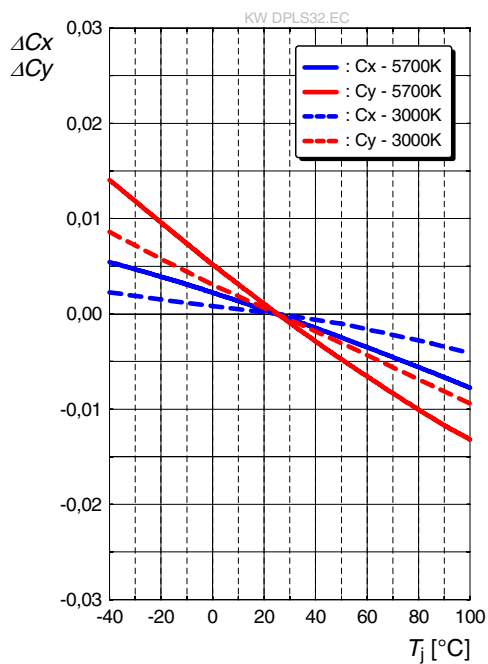

### Max. Permissible Forward Current

$I_F = f(T)$

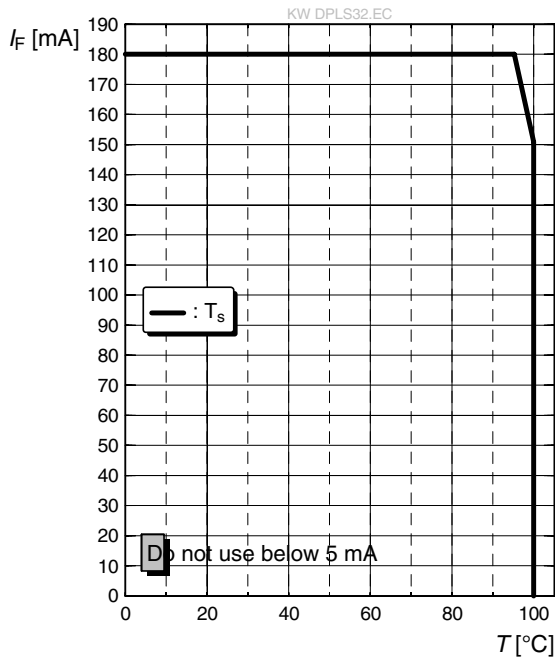

### Permissible Pulse Handling Capability

$I_F = f(t_p)$ ; D: Duty cycle

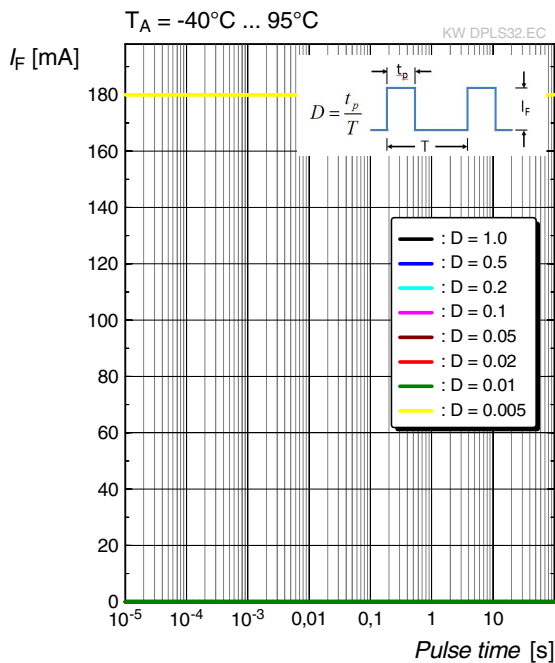

### Permissible Pulse Handling Capability

$I_F = f(t_p)$ ; D: Duty cycle

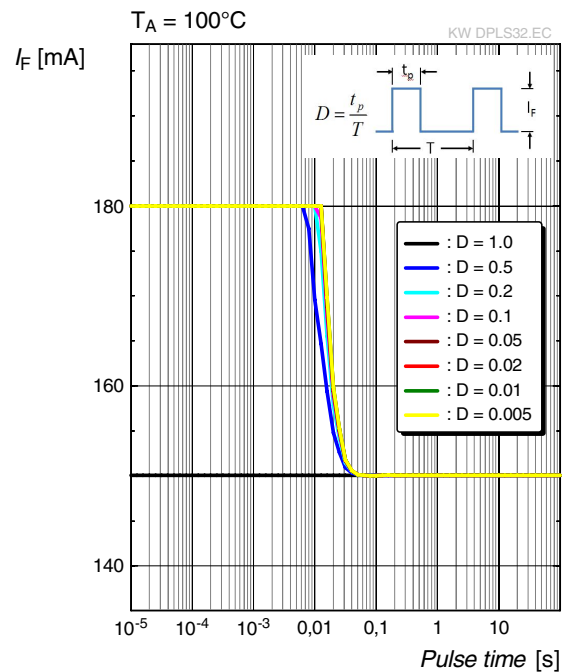



**Dimensional Drawing** <sup>8)</sup>

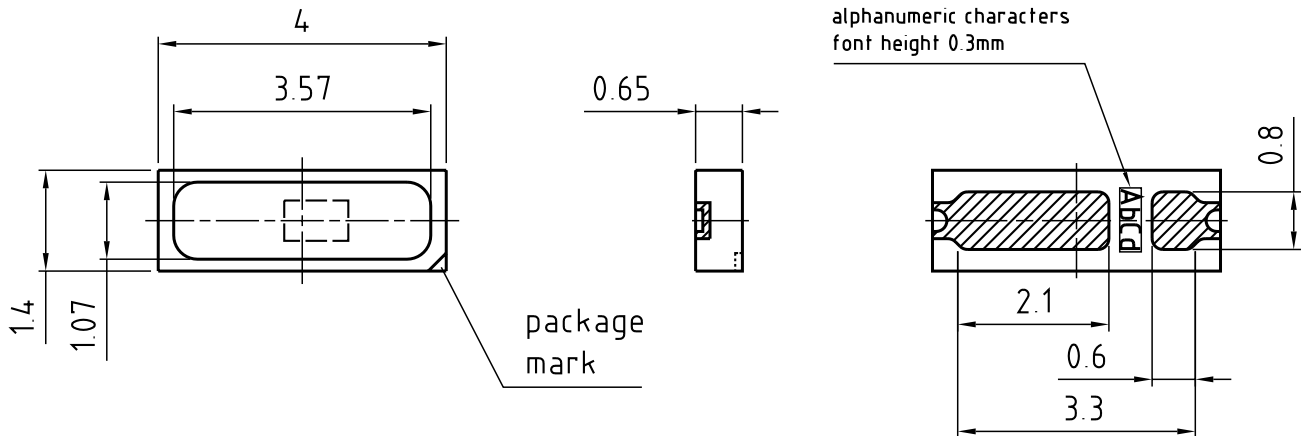

general tolerance  $\pm 0.1$   
lead finish Ag 

C63062-A4202-A10..-01

**Approximate Weight:** 10.0 mg

**Package marking:** Cathode

**Corrosion test:** Class: 1B  
Test condition: 25°C / 75 % RH / 200ppb SO<sub>2</sub>, 200ppb NO<sub>2</sub>, 10ppb H<sub>2</sub>S, 10ppb Cl<sub>2</sub> / 21 days (EN 60068-2-60 (Method 4))

**ESD advice:** The device is protected by ESD device which is connected in parallel to the Chip.

Electrical internal circuit

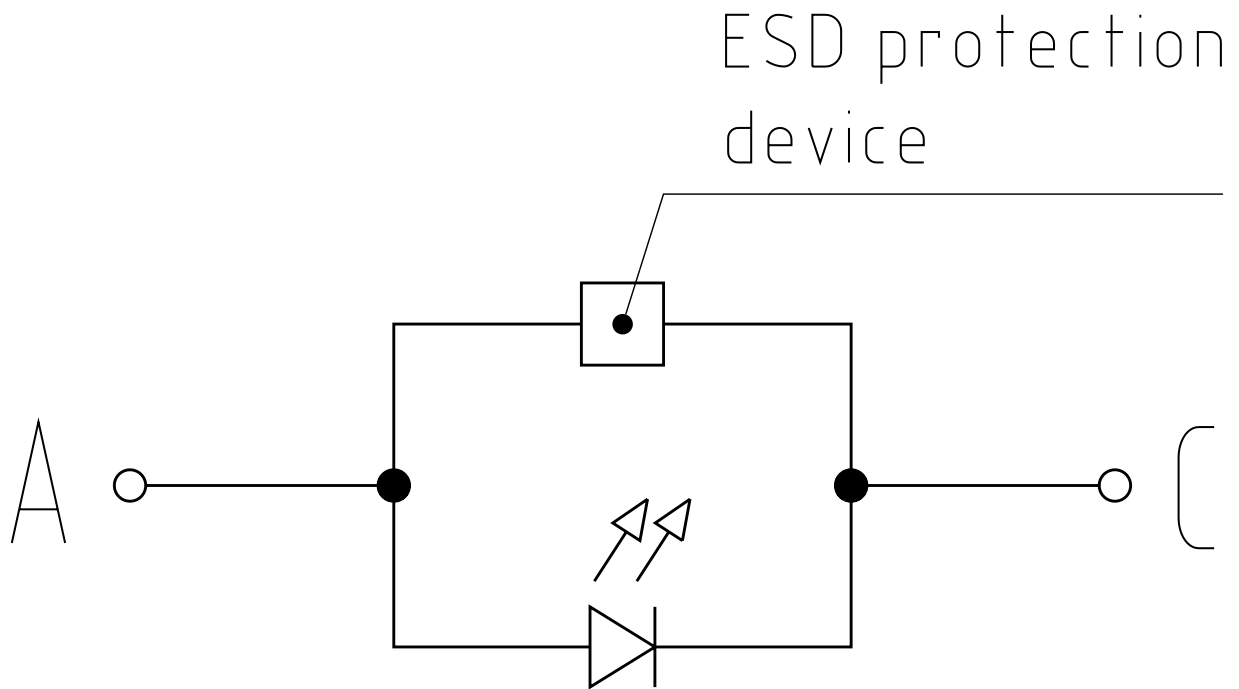

## Recommended Solder Pad <sup>8)</sup>

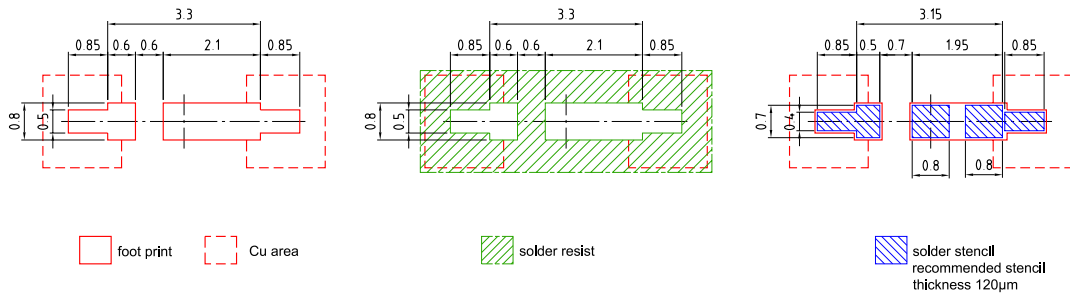

Component Location on Pad

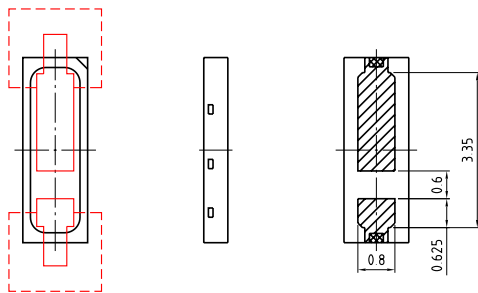

E062.3010.228-01

For superior solder joint connectivity results we recommend soldering under standard nitrogen atmosphere. Package not suitable for ultra sonic cleaning.

## Reflow Soldering Profile

Product complies to MSL Level 3 acc. to JEDEC J-STD-020E

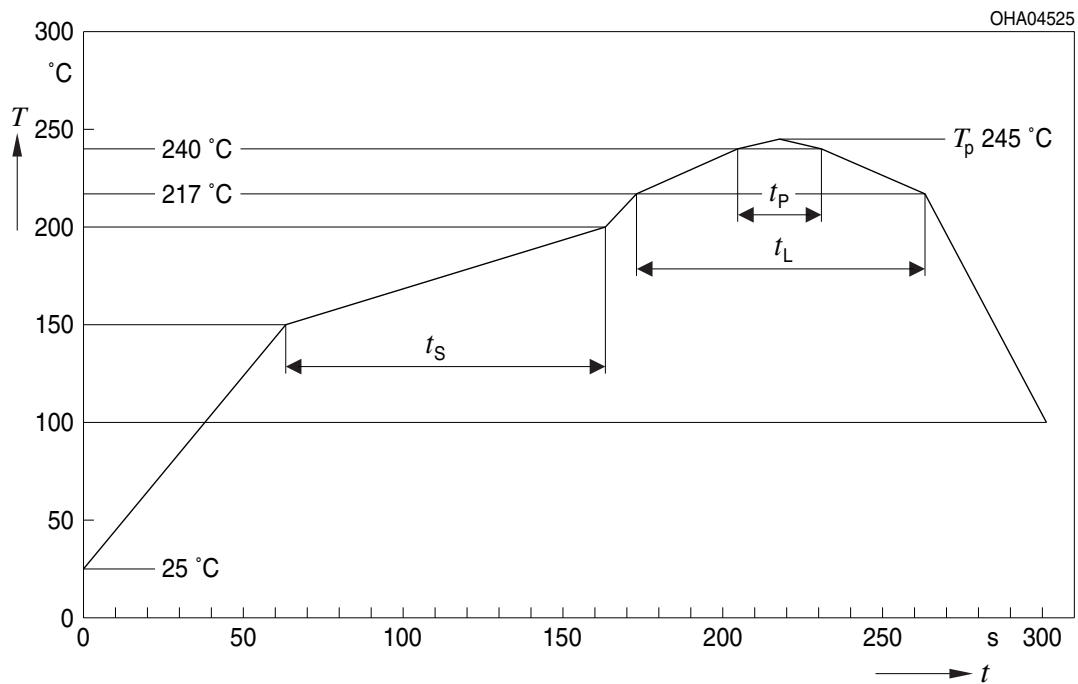

Profile Feature	Symbol	Pb-Free (SnAgCu) Assembly			Unit
		Minimum	Recommendation	Maximum	
Ramp-up rate to preheat <sup>*)</sup> 25 °C to 150 °C			2	3	K/s
Time $t_s$ $T_{Smin}$ to $T_{Smax}$	$t_s$	60	100	120	s
Ramp-up rate to peak <sup>*)</sup> $T_{Smax}$ to $T_p$			2	3	K/s
Liquidus temperature	$T_L$		217		°C
Time above liquidus temperature	$t_L$		80	100	s
Peak temperature	$T_p$		245	260	°C
Time within 5 °C of the specified peak temperature $T_p - 5$ K	$t_p$	10	20	30	s
Ramp-down rate* $T_p$ to 100 °C			3	6	K/s
Time 25 °C to $T_p$				480	s

All temperatures refer to the center of the package, measured on the top of the component

\* slope calculation  $DT/Dt$ :  $Dt$  max. 5 s; fulfillment for the whole T-range

**Taping** <sup>8)</sup>

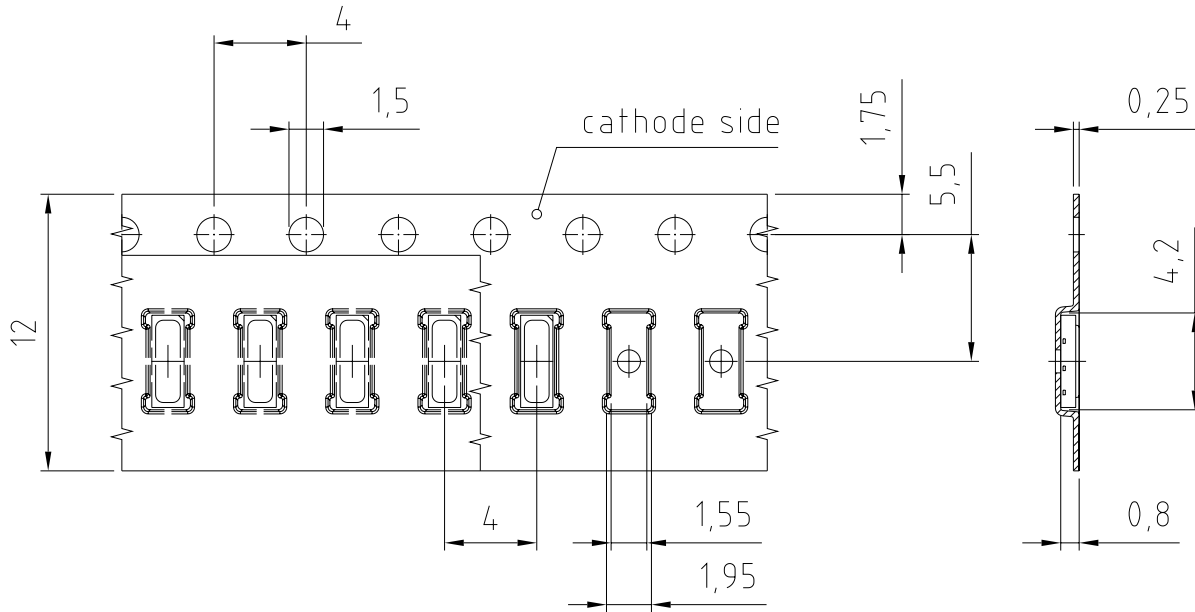

C63062-A4353-B6-01

**Tape and Reel** <sup>9)</sup>



**Reel dimensions [mm]**

A	W	N <sub>min</sub>	W <sub>1</sub>	W <sub>2max</sub>	Pieces per PU
180 mm	12 + 0.3 / - 0.1	60	12.4 + 2	18.4	3000

## Barcode-Product-Label (BPL)

**OSRAM Opto Semiconductors** LX XXXX    BIN1: XX-XX-X-XXX-X

RoHS Compliant

(6P) BATCH NO: 1234567890 ML Temp    ST  
X    XXX °C X

(1T) LOT NO: 1234567890 (9D) D/C: 1234

(X) PROD NO: 123456789(Q)QTY: 9999 (G) GROUP: XX-XX-X-X

Pack: RXX  
DEMY    XXX  
X\_X123\_1234.1234 X



OHA04563

## Dry Packing Process and Materials <sup>8)</sup>

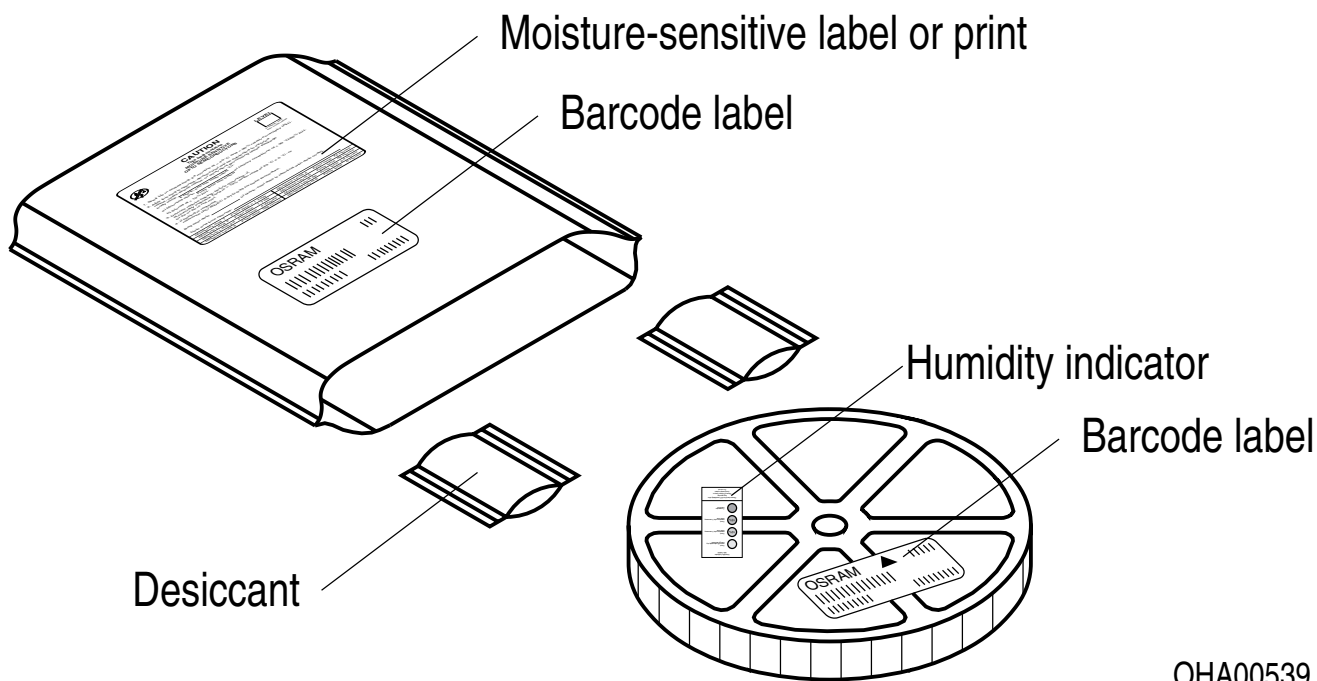

OHA00539

Moisture-sensitive product is packed in a dry bag containing desiccant and a humidity card according JEDEC-STD-033.

## Transportation Packing and Materials <sup>8)</sup>

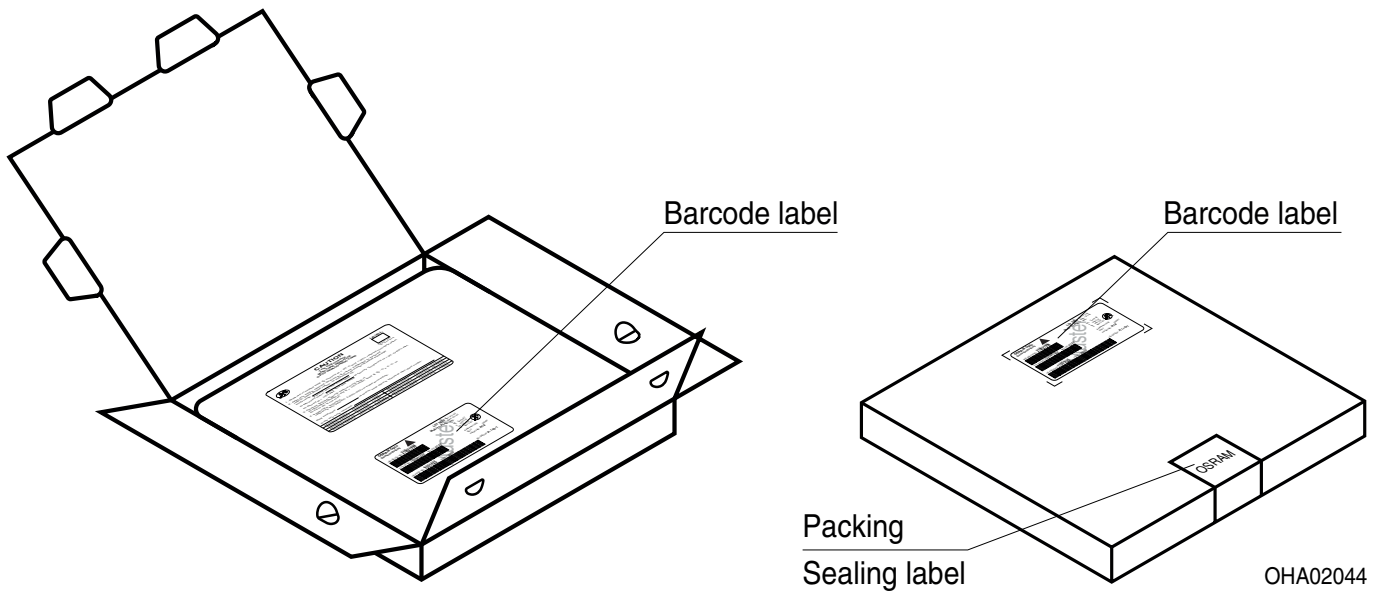

### Dimensions of transportation box in mm

Width	Length	Height
195 ± 5 mm	195 ± 5 mm	30 ± 5 mm



## Notes

The evaluation of eye safety occurs according to the standard IEC 62471:2006 (photo biological safety of lamps and lamp systems). Within the risk grouping system of this IEC standard, the device specified in this data sheet falls into the class **exempt group (exposure time 10000 s)**. Under real circumstances (for exposure time, conditions of the eye pupils, observation distance), it is assumed that no endangerment to the eye exists from these devices. As a matter of principle, however, it should be mentioned that intense light sources have a high secondary exposure potential due to their blinding effect. When looking at bright light sources (e.g. headlights), temporary reduction in visual acuity and afterimages can occur, leading to irritation, annoyance, visual impairment, and even accidents, depending on the situation.

Subcomponents of this device contain, in addition to other substances, metal filled materials including silver. Metal filled materials can be affected by environments that contain traces of aggressive substances. Therefore, we recommend that customers minimize device exposure to aggressive substances during storage, production, and use. Devices that showed visible discoloration when tested using the described tests above did show no performance deviations within failure limits during the stated test duration. Respective failure limits are described in the IEC60810.

For further application related informations please visit [www.osram-os.com/appnotes](http://www.osram-os.com/appnotes)

## Disclaimer

### Disclaimer

Language english will prevail in case of any discrepancies or deviations between the two language wordings.

### Attention please!

The information describes the type of component and shall not be considered as assured characteristics. Terms of delivery and rights to change design reserved. Due to technical requirements components may contain dangerous substances.

For information on the types in question please contact our Sales Organization.

If printed or downloaded, please find the latest version on the OSRAM OS website.

### Packing

Please use the recycling operators known to you. We can also help you – get in touch with your nearest sales office.

By agreement we will take packing material back, if it is sorted. You must bear the costs of transport. For packing material that is returned to us unsorted or which we are not obliged to accept, we shall have to invoice you for any costs incurred.

### Product safety devices/applications or medical devices/applications

OSRAM OS components are not developed, constructed or tested for the application as safety relevant component or for the application in medical devices.

In case Buyer – or Customer supplied by Buyer– considers using OSRAM OS components in product safety devices/applications or medical devices/applications, Buyer and/or Customer has to inform the local sales partner of OSRAM OS immediately and OSRAM OS and Buyer and /or Customer will analyze and coordinate the customer-specific request between OSRAM OS and Buyer and/or Customer.

---

## Glossary

- 1) **Brightness:** Brightness values are measured during a current pulse of typically 25 ms, with an internal reproducibility of  $\pm 8\%$  and an expanded uncertainty of  $\pm 11\%$  (acc. to GUM with a coverage factor of  $k = 3$ ).
- 2) **Reverse Operation:** Not designed for reverse operation. Continuous reverse operation can cause migration and damage of the device.
- 3) **Forward Voltage:** The forward voltage is measured during a current pulse of typically 8 ms, with an internal reproducibility of  $\pm 0.05\text{ V}$  and an expanded uncertainty of  $\pm 0.1\text{ V}$  (acc. to GUM with a coverage factor of  $k = 3$ ).
- 4) **Thermal Resistance:**  $R_{th\ max}$  is based on statistic values ( $6\sigma$ ).
- 5) **Typical Values:** Due to the special conditions of the manufacturing processes of semiconductor devices, the typical data or calculated correlations of technical parameters can only reflect statistical figures. These do not necessarily correspond to the actual parameters of each single product, which could differ from the typical data and calculated correlations or the typical characteristic line. If requested, e.g. because of technical improvements, these typ. data will be changed without any further notice.
- 6) **Chromaticity coordinate groups:** Chromaticity coordinates are measured during a current pulse of typically 25 ms, with an internal reproducibility of  $\pm 0.005$  and an expanded uncertainty of  $\pm 0.01$  (acc. to GUM with a coverage factor of  $k = 3$ ).
- 7) **Characteristic curve:** In the range where the line of the graph is broken, you must expect higher differences between single devices within one packing unit.
- 8) **Tolerance of Measure:** Unless otherwise noted in drawing, tolerances are specified with  $\pm 0.1$  and dimensions are specified in mm.
- 9) **Tape and Reel:** All dimensions and tolerances are specified acc. IEC 60286-3 and specified in mm.

Published by OSRAM Opto Semiconductors GmbH EU RoHS and China RoHS compliant product  
Leibnizstraße 4, D-93055 Regensburg  
www.osram-os.com © All Rights Reserved.



此产品符合欧盟 RoHS 指令的要求；  
按照中国的相关法规和标准，不含有毒有害物质或元素。